

1.0A USB Port/Adapter Li-Ion/Polymer Battery Charger

General Description

The AAT3690 BatteryManager is a highly integrated single-cell lithium-ion/polymer battery charger IC designed to operate with USB port and AC adapter inputs. It requires the minimum number of external components.

The AAT3690 precisely regulates battery charge voltage and current for 4.2V lithium-ion/polymer battery cells. Adapter charge current rates can be programmed up to 1.0A. In the absence of an adapter and with a USB port connected, the battery can also be charged by USB power. The USB charge current can be programmed up to 1A. A Charge Reduction Loop is also built in to allow users to charge the battery with the available current from a USB port, while keeping the port voltage regulated. USB charging is disabled when an adapter is present.

Battery temperature and charge state are fully monitored for fault conditions. In the event of an over-voltage or over-temperature condition, the device will automatically shut down, thus protecting the charging device, control system, and the battery under charge. Status monitor output pins are provided to indicate the battery charge status by directly driving two external LEDs.

The AAT3690 is available in a Pb-free, thermally-enhanced, space-saving 12-pin 3 × 3mm TDFN package and is rated over the -40°C to +85°C temperature range.

Features

- USB/AC Adapter System Power Charger
 - USB: Programmable up to 1.0A
 - Adapter: Programmable up to 1.0A
- 4.0V to 5.5V Input Voltage Range
- Adapter Presence Automatically Disables USB Charging
- High Level of Integration With Internal:
 - Charging Devices
 - Reverse Blocking Diodes
 - Current Sensing
- Automatic Recharge Sequencing
- Digital Thermal Regulation in ADP Charge
- Charge Reduction Loop in USB Charge
- Battery Temperature Monitoring
- Full Battery Charge Auto Turn-Off
- Over-Current Protection
- Over-Voltage Protection
- Emergency Thermal Protection
- Power On Reset and Soft Start
- Serial Interface Status Reporting
- 12-Pin 3 × 3mm TDFN Package

Applications

- Cellular Telephones
- Digital Still Cameras
- Hand-Held PCs
- MP3 Players
- Personal Data Assistants (PDAs)
- Other Lithium-Ion/Polymer Battery-Powered Devices

Typical Application

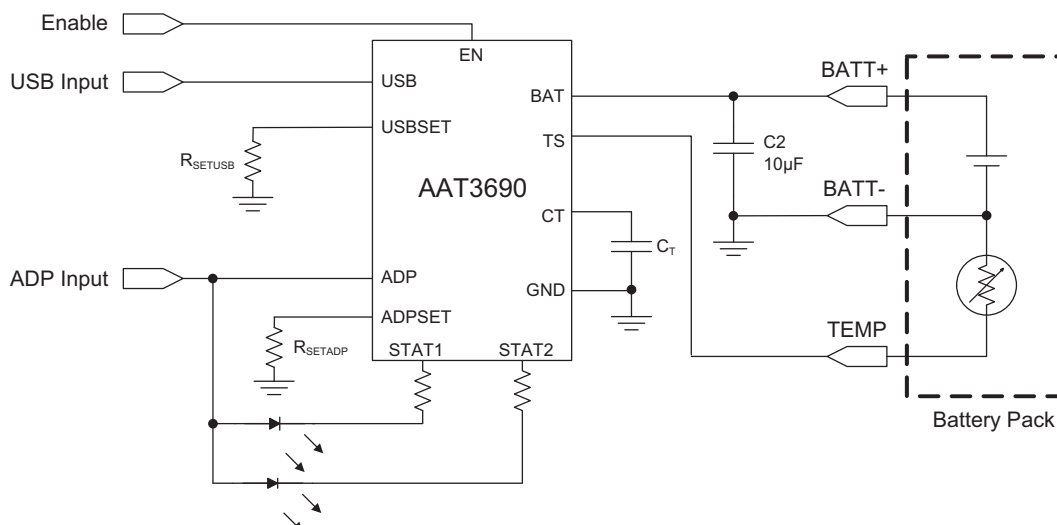

1.0A USB Port/Adapter Li-Ion/Polymer Battery Charger**Pin Descriptions**

| Pin # | Name | Type | Function |
|-------|--------|--------|--|
| 1, 10 | USB | In | USB power supply input. |
| 2 | BAT | In/Out | Battery charging and sensing. |
| 3 | ADP | In | Adapter power supply input. |
| 4 | GND | Ground | Ground connection. |
| 5 | EN | In | Enable pin. Logic high enables the IC. When open, this pin is internally pulled up to the higher voltage of ADP and USB inputs. |
| 6 | TS | In/Out | Connect to 10kΩ NTC thermistor. When TS is open, the battery temperature sensing function is disabled. |
| 7 | STAT2 | Out | Battery charge status indicator pin to drive an LED: active low, open-drain. |
| 8 | STAT1 | Out | Battery charge status indicator pin to drive an LED: active low, open-drain. |
| 9 | CT | In/Out | Timing capacitor to adjust internal watchdog timer. Set maximum charge time for adapter powered CC and CV charge modes. The watchdog timer only sets the timers for adapter battery charging; there is no timeout for the battery charging from the USB input. If timing function is not needed, terminate this pin to ground. |
| 11 | USBSET | In/Out | Connect a resistor between this pin and GND to set USB charging current. |
| 12 | ADPSET | In/Out | Connect a resistor between this pin and GND to set adapter charging current. |
| EP | | | Exposed paddle (bottom); connect to GND directly beneath package. |

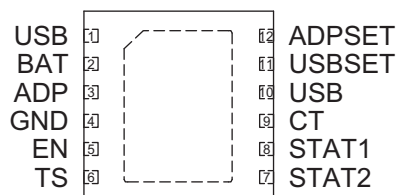
Pin Configuration**TDFN33-12
(Top View)**

1.0A USB Port/Adapter Li-Ion/Polymer Battery Charger**Absolute Maximum Ratings¹**

| Symbol | Description | Value | Units |
|------------|---|---------------------|-------|
| V_P | USB, ADP, <30ms, Duty Cycle <10% | -0.3 to 7.0 | V |
| V_P | USB, ADP Continuous | -0.3 to 6.0 | |
| V_N | BAT, USBSEL, USBSET, ADPSET, STAT1, STAT2, TS, CT, EN | -0.3 to $V_P + 0.3$ | |
| T_J | Operating Junction Temperature Range | -40 to 150 | °C |
| T_{LEAD} | Maximum Soldering Temperature (at leads) | 300 | |

Thermal Information²

| Symbol | Description | Value | Units |
|---------------|----------------------------|-------|-------|
| θ_{JA} | Maximum Thermal Resistance | 50 | °C/W |
| P_D | Maximum Power Dissipation | 2.0 | W |

1. Stresses above those listed in Absolute Maximum Ratings may cause permanent damage to the device. Functional operation at conditions other than the operating conditions specified is not implied. Only one Absolute Maximum Rating should be applied at any one time.

2. Mounted on a FR4 board.

DATA SHEET

AAT3690

1.0A USB Port/Adapter Li-Ion/Polymer Battery Charger

Electrical Characteristics¹

$V_{ADP} = 5V$, $T_A = -40^{\circ}C$ to $+85^{\circ}C$, unless otherwise noted. Typical values are at $T_A = 25^{\circ}C$.

| Symbol | Description | Conditions | Min | Typ | Max | Units |
|-----------------------------------|---|-------------------------------------|-------|----------------------|-------|-------------------|
| Operation | | | | | | |
| USB, ADP | USB Port or Adapter Voltage Range | | 4.0 | | 5.5 | V |
| V_{U_DSBL} | ADP Voltage Level to Disable USB Charging | | 4.25 | 4.5 | 4.7 | V |
| V_{UVLO} | Under-Voltage Lockout | Rising Edge | | 3.0 | | V |
| | Under-Voltage Lockout Hysteresis | | | 150 | | mV |
| I_{OP} | Operating Current | CC Charge Current = 500mA | | 0.75 | 1.5 | mA |
| I_{SLEEP} | Sleep Mode Current | $V_{BAT} = 4.25V$ | | 2.0 | 5.0 | μA |
| $I_{Leakage}$ | Reverse Leakage Current from BAT Pin | $V_{BAT} = 4V$, USB, ADP Pins Open | | 1.0 | | μA |
| Voltage Regulation | | | | | | |
| V_{BAT_EOC} | End of Charge Voltage Accuracy | | 4.158 | 4.2 | 4.242 | V |
| $\Delta V_{BAT}/V_{BAT}$ | EOC Voltage Tolerance | | | 0.5 | | % |
| V_{RCH} | Battery Recharge Voltage Threshold | | | $V_{BAT_EOC} - 0.1$ | | V |
| V_{USB_CHR} | USB Charge Reduction Regulation | | 4.3 | 4.5 | 4.64 | V |
| Current Regulation | | | | | | |
| I_{CH} | Charge Current | ADP Input | 100 | | 1000 | mA |
| | | USB Input | 50 | | 1000 | |
| $\Delta I_{CH}/I_{CH}$ | Charge Current Regulation Tolerance | | | 10 | | % |
| V_{ADPSET} | ADPSET Pin Voltage | In CC Mode | | 2.0 | | V |
| V_{USBSET} | USBSET Pin Voltage | In CC Mode | | 2.0 | | V |
| K_{IADP} | Current Set Factor: I_{CHARGE}/I_{ADPSET} | | | 4000 | | |
| K_{IUSB} | Current Set Factor: I_{CHARGE}/I_{USBSET} | | | 2000 | | |
| Charging Devices | | | | | | |
| $R_{DS(ON)A}$ | Adapter Charging Transistor On Resistance | $V_{IN} = 5.5V$ | 0.2 | 0.25 | 0.35 | Ω |
| $R_{DS(ON)U}$ | USB Charging Transistor On Resistance | $V_{IN} = 5.5V$ | 0.4 | 0.5 | 0.65 | Ω |
| Logic Control / Protection | | | | | | |
| $V_{EN(H)}$ | Input High Threshold | | 1.6 | | | V |
| $V_{EN(L)}$ | Input Low Threshold | | | | 0.4 | V |
| T_C | Constant Current Mode Time Out (ADP mode only) | $C_{CT} = 100nF$, $V_{ADP} = 5.5V$ | | 3.0 | | Hour |
| T_V | Constant Voltage Mode Time Out (ADP mode only) | $C_{CT} = 100nF$, $V_{ADP} = 5.5V$ | | 3.0 | | Hour |
| V_{STAT} | Output Low Voltage | STAT Pin Sinks 4mA | | | 0.4 | V |
| I_{STAT} | STAT Pin Current Sink Capability | | | 8.0 | | mA |
| V_{OVP} | Over-Voltage Protection Threshold | | | 4.4 | | V |
| I_{OCP} | Over-Current Protection Threshold | | | 105 | | % I_{CH_CC} |
| | Charge Termination Threshold Current I_{TERM}/I_{CHG} | | | 7.5 | | % |
| I_{TS} | Current Source from TS Pin | | 70 | 80 | 90 | μA |
| TS1 | TS Hot Temperature Fault | Threshold | 310 | 330 | 350 | mV |
| | | Hysteresis | | 15 | | |
| TS2 | TS Cold Temperature Fault | Threshold | 2.2 | 2.3 | 2.4 | V |
| | | Hysteresis | | 10 | | |
| T_{REG} | Thermal Loop Regulation | | | 90 | | $^{\circ}C$ |
| T_{LOOP_IN} | Thermal Loop Entering Threshold | | | 110 | | $^{\circ}C$ |
| T_{LOOP_OUT} | Thermal Loop Exiting Threshold | | | 85 | | $^{\circ}C$ |
| T_{OVSD} | Over-Temperature Shutdown Threshold | | | 145 | | $^{\circ}C$ |

1. The AAT3690 output charge voltage is specified over the 0° to 70°C ambient temperature range; operation over the -40°C to +85°C temperature range is guaranteed by design.

1.0A USB Port/Adapter Li-Ion/Polymer Battery Charger

Typical Characteristics

$I_{FASTCHARGE}$ vs. R_{SET}

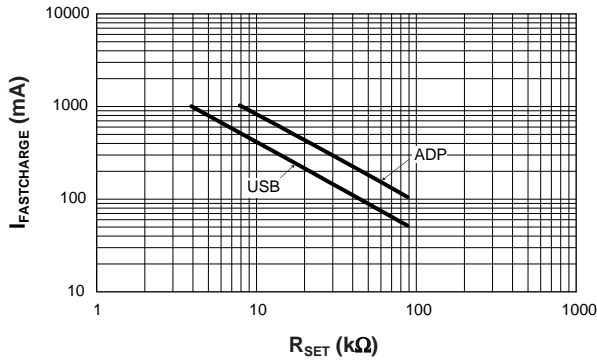

Battery Voltage vs. Supply Voltage

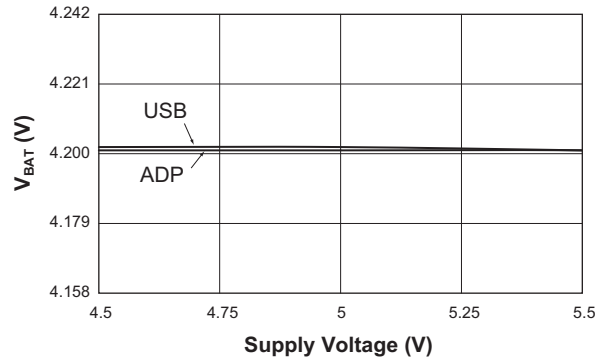

Recharge Voltage vs. Temperature

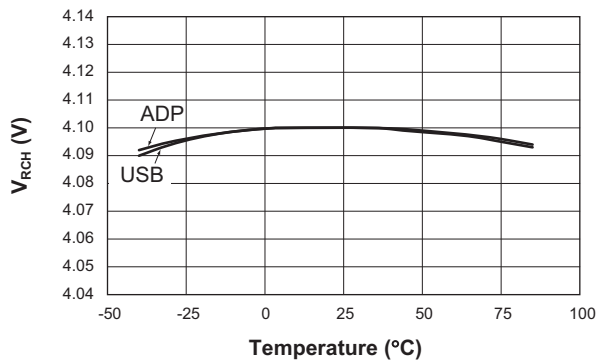

End of Charge Voltage vs. Temperature

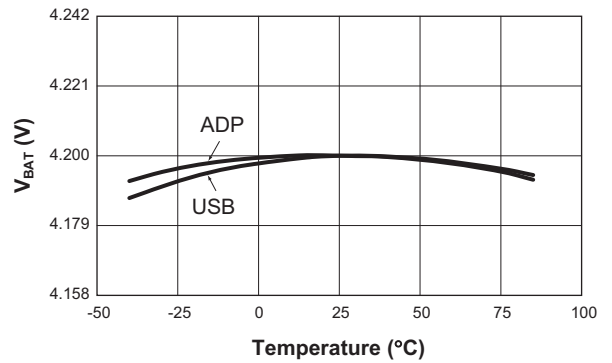

Fast Charge Current vs. Temperature
($R_{ADPSET} = 8.06k\Omega$; $R_{USBSET} = 8.06k\Omega$)

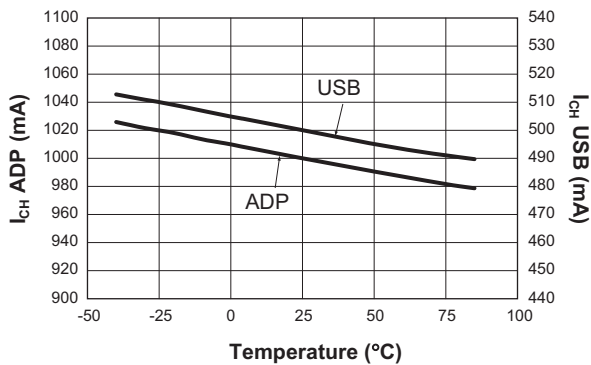

Adapter Charging Current vs. Battery Voltage
($R_{ADPSET} = 8.06k\Omega$)

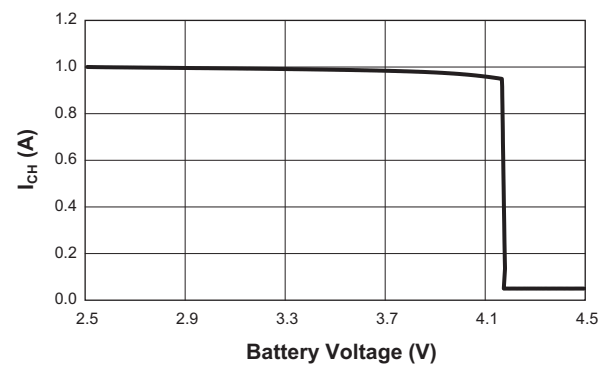

1.0A USB Port/Adapter Li-Ion/Polymer Battery Charger

Typical Characteristics

USB Charging Current vs. Battery Voltage
($R_{USBSET} = 8.06k\Omega$)

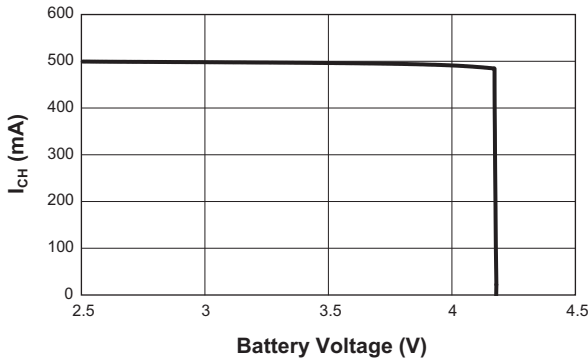

Adapter Fast Charge Current vs. Supply Voltage
($R_{ADPSET} = 8.06k\Omega$)

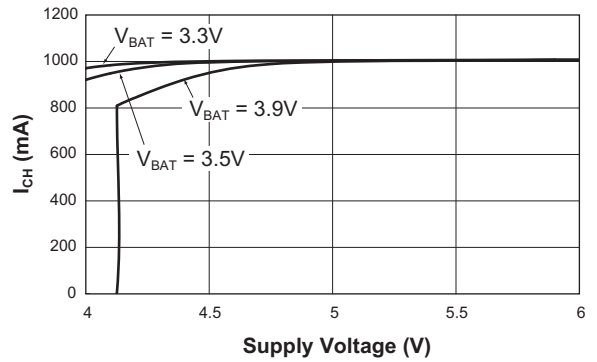

USB Fast Charge Current vs. Supply Voltage
($R_{USBSET}; USB = 8.06k\Omega$)

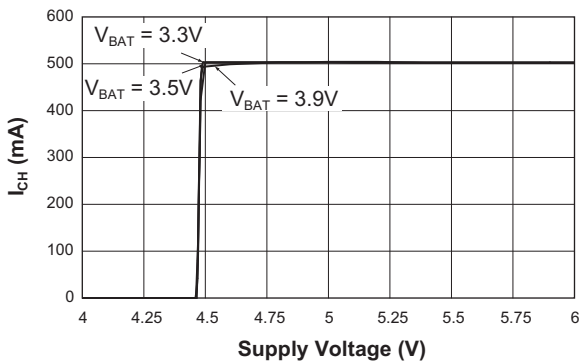

USB Fast Charge Current vs. Supply Voltage
($R_{USBSET}; USB = 8.06k\Omega$)

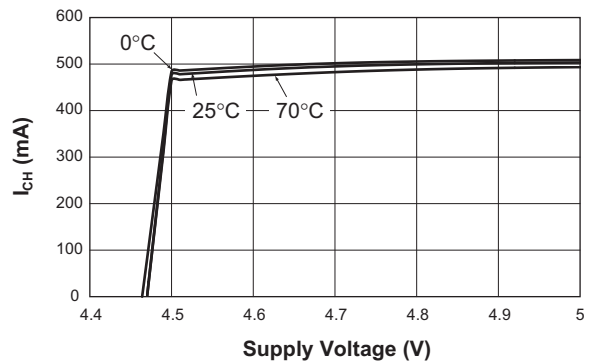

V_{IH} vs. Supply Voltage
EN Pin (Rising)

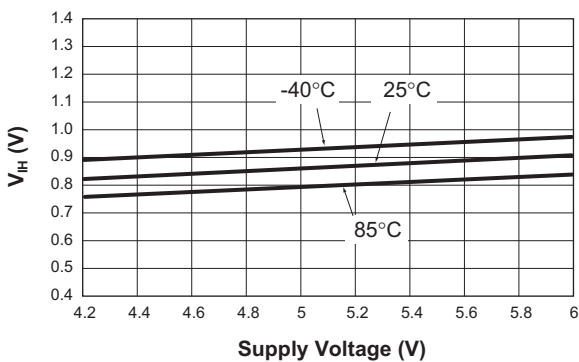

V_{IL} vs. Supply Voltage
EN Pin (Falling)

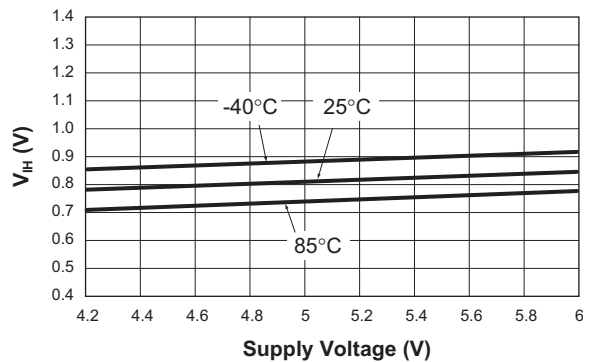

1.0A USB Port/Adapter Li-Ion/Polymer Battery Charger

Typical Characteristics

Adapter Mode Supply Current vs. ADPSET Resistor

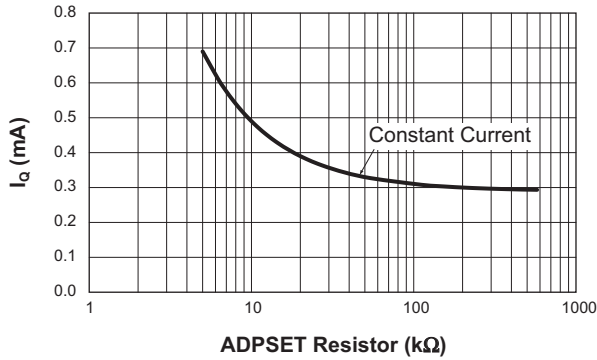

USB Charge Current vs. Time
($R_{USBSET} = 8.06k\Omega$)

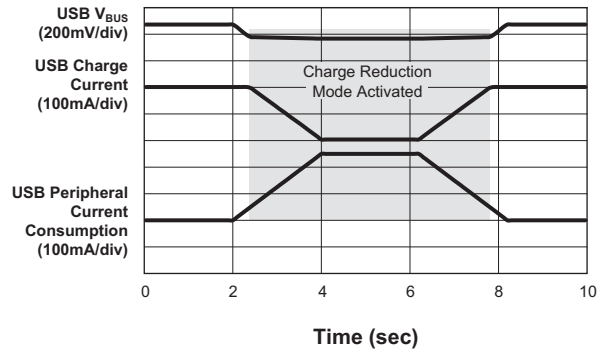

Counter Timeout vs. Temperature
($CT = 0.1\mu F$)

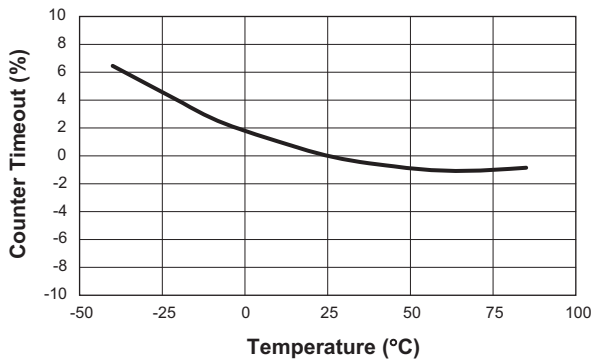

CT Pin Capacitance vs. Counter Timeout

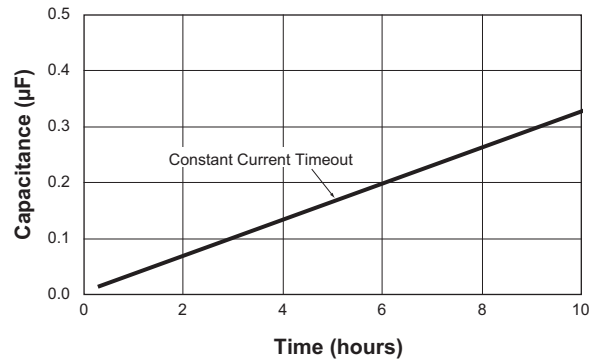

Temperature Sense Output Current vs. Temperature

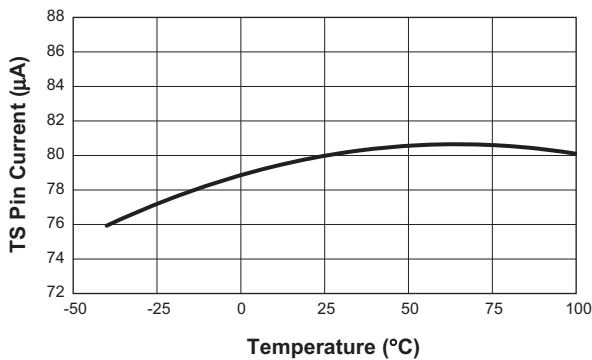

1.0A USB Port/Adapter Li-Ion/Polymer Battery Charger

Functional Block Diagram

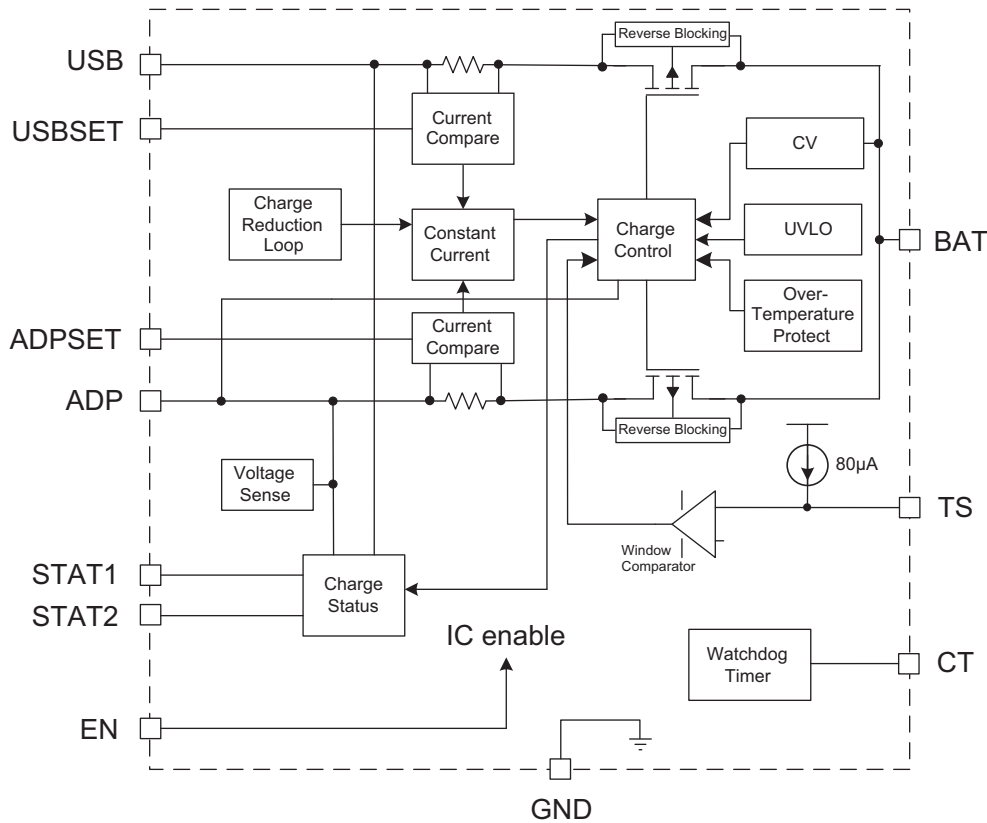

Functional Description

The AAT3690 is a highly integrated single-cell lithium-ion/polymer battery charger IC designed to operate with USB port and AC adapter inputs, while requiring a minimum number of external components. The AAT3690 precisely regulates battery charge voltage and current for 4.2V lithium-ion/polymer battery cells.

The adapter charge input constant current level can be programmed up to 1.0A for rapid charging applications. In the absence of a high-current adapter input source, the AAT3690 can be powered from a USB port V_{BUS} supply. The USB constant charge current can be externally programmed for maximum constant current charge levels up to 1A.

The USB mode has an automatic Charge Reduction Loop control to allow users to charge the battery with limited available current from a USB port while maintaining the regulated port voltage. This system assures the battery

charge function will not overload a USB port while charging if other system demands also share power with the respective port supply. The USB charge function is automatically disabled when an adapter input power source greater than 4.4V is present.

Status monitor output pins are provided to indicate the battery charge status by directly driving two external LEDs.

Battery temperature and charge state are fully monitored for fault conditions. In the event of an over-voltage or over-temperature condition, the device will automatically shut down, thus protecting the charging device, control system, and the battery under charge. In addition to internal charge controller thermal protection, the AAT3690 also provides a temperature sense feedback function (TS pin) from the battery to shut down the device in the event the battery exceeds its own thermal limit during charging.

1.0A USB Port/Adapter Li-Ion/Polymer Battery Charger

Charging Operation

Regardless of which charge input function is selected (i.e., either the adapter input or USB input), the AAT3690 has three basic modes for the battery charge cycle: constant current/fast charge; constant voltage; and end of charge (see Figure 1).

Fast Charge / Constant Current Charging

When enabled, the AAT3690 begins constant-current fast charging. The fast charge Constant Current (I_{CC}) amplitude is determined by the charge mode, ADP or USB, and is programmed by the user via the R_{SETADP} and R_{SETUSB} resistors. The AAT3690 remains in constant current charge mode until the battery reaches the voltage regulation point, V_{BAT} .

Constant Voltage Charging

The system transitions to a constant voltage charging mode when the battery voltage reaches output charge regulation threshold (V_{BAT}) during the constant current fast charge phase. The regulation voltage level is factory programmed to 4.2V ($\pm 1\%$). The charge current in the

constant voltage mode drops as the battery cell under charge reaches its maximum capacity.

End of Charge Cycle Termination and Recharge Sequence

When the charge current drops to 7.5% of the programmed fast charge current level in the constant voltage mode, the device terminates charging and goes into a standby state. The charger will remain in a standby state until the battery voltage decreases to a level below the battery recharge voltage threshold (V_{RCH}).

When the input supply is disconnected or drops below UVLO or $EN = 0$, the charger will automatically enter power-saving sleep mode. Consuming an ultra-low $2\mu A$ in sleep mode, the AAT3690 minimizes battery drain when it is not charging. This feature is particularly useful in applications where the input supply level may fall below the battery charge or under-voltage lockout level. In such cases where the AAT3690 input voltage drops, the device will enter the sleep mode and automatically resume charging once the input supply has recovered from its fault condition.

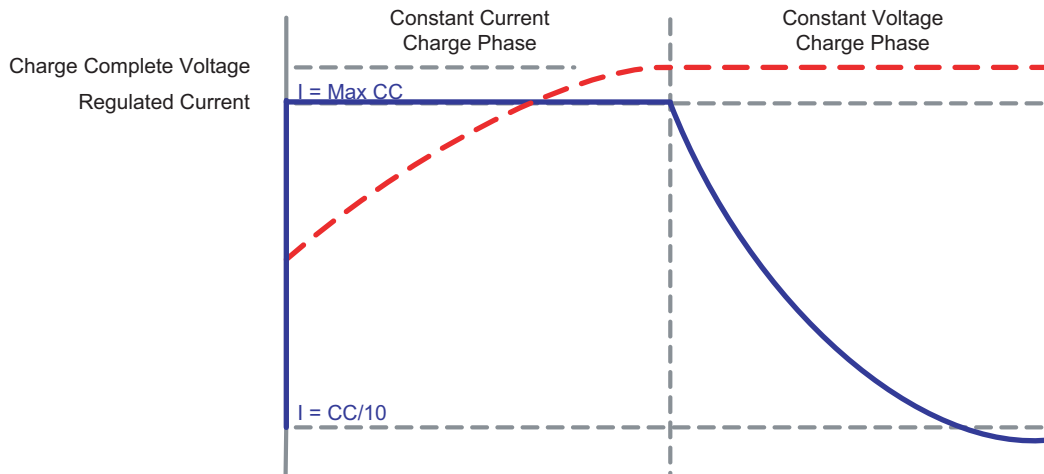
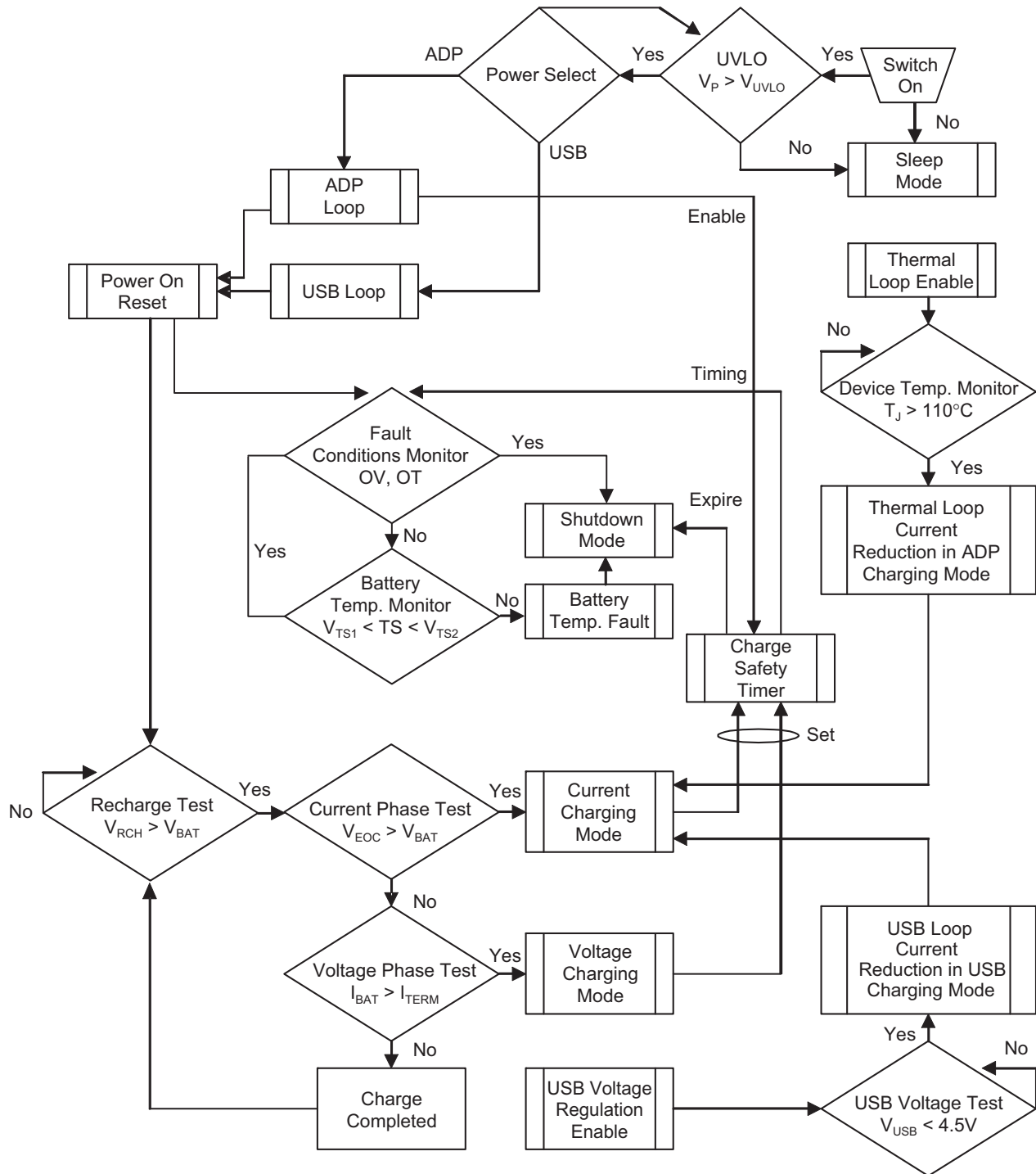

Figure 1: Current vs. Voltage Profile During Charging Phases.

1.0A USB Port/Adapter Li-Ion/Polymer Battery Charger

System Operation Flowchart



1.0A USB Port/Adapter Li-Ion/Polymer Battery Charger

Application Information

AC Adapter/USB System Power Charging

Adapter Mode

In the adapter mode, constant current charge levels up to 1.0A can be programmed by the user. The AAT3690 system control will always select the adapter input over the USB supply input whenever adapter voltage is present on the ADP pin. The AAT3690 will operate from the adapter input over a 4.0V to 5.5V range.

The constant current fast charge current for the adapter input mode is set by the R_{SETADP} resistor connected between ADPSET and ground. Refer to Table 1 for recommended R_{SETADP} values for a desired constant current charge level. The precise charging function in the adapter mode may be read from the status LEDs. Please refer to the Battery Charge Status Indication discussion in this datasheet for further details.

Thermal Loop Control

Due to the integrated nature of the linear charging control pass device for the adapter mode, a special thermal loop control system has been employed to maximize charging current under all operating conditions. The thermal management system measures the internal circuit die temperature and reduces the fast charge current when the device exceeds a preset internal temperature control threshold. Once the thermal loop control becomes active, the fast charge current is initially reduced by a factor of 0.44.

The initial thermal loop current can be estimated by the following equation:

$$I_{TLOOP} = I_{CC} \cdot 0.44$$

The thermal loop control re-evaluates the circuit die temperature every three seconds and adjusts the fast charge current back up in small steps to the full fast charge current level or until an equilibrium current is discovered and maximized for the given ambient temperature condition. In the manner the thermal loop controls the system charge level, the AAT3690 will always provide the highest level of constant current in the fast charge mode possible for any given ambient temperature condition.

Adapter Input Charge Inhibit and Resume

The AAT3690 has an under-voltage lockout and power on reset feature so that if the input supply to the adapter pin drops below the UVLO threshold the charger will sus-

pend charging and shut down. When power is re-applied to the adapter pin or the UVLO condition recovers and $V_{ADP} > V_{BAT}$, the system charge control will assess the state of charge on the battery cell and will automatically resume charging in the appropriate mode for the condition of the battery.

USB Mode

The AAT3690 provides an input for intelligent USB charging. When no voltage is present on the adapter input pin, the charge controller will automatically switch to accepting power from the USB input. The USB charge may be user programmed to any level between 50mA and 1A by selecting the appropriate resistor values for R_{SETUSB} . Refer to Table 1 for recommended R_{SETUSB} values for the desired USB input constant current charge levels.

USB Charge Reduction

In many instances, product system designers do not know the real properties of a potential USB port used to supply power to the battery charger. Typically, powered USB ports found on desktop and notebook PCs should supply up to 500mA. In the event a USB port being used to supply the charger is unable to provide the programmed fast charge current or if the system under charge must also share supply current with other functions, the AAT3690 will automatically reduce USB fast charge current to maintain port integrity and protect the host system.

| I_{CC} | ADP R_{SET} (k Ω) | USB R_{SET} (k Ω) |
|----------|--------------------------------|--------------------------------|
| 50 | N/A | 86.6 |
| 75 | N/A | 57.6 |
| 100 | 84.5 | 42.2 |
| 200 | 43.2 | 21.0 |
| 300 | 28.0 | 13.7 |
| 400 | 21.0 | 10.2 |
| 500 | 16.9 | 8.06 |
| 600 | 13.3 | 6.65 |
| 700 | 11.5 | 5.62 |
| 800 | 10.2 | 4.87 |
| 900 | 9.09 | 4.32 |
| 1000 | 8.06 | 3.83 |

Table 1: Resistor Values.

The USB charge reduction system becomes active when the voltage on the USB input falls below the USB charge reduction threshold, which is typically 4.5V. The charge reduction system will reduce the fast charge current

1.0A USB Port/Adapter Li-Ion/Polymer Battery Charger

level in a linear fashion until the voltage sensed on the USB input recovers above the charge reduction threshold voltage.

USB Input Charge Inhibit and Resume

The AAT3690 UVLO and power on reset feature will function when the USB input pin voltage level drops below the UVLO threshold. At this point, the charger will suspend charging and shut down. When power is re-applied to the USB pin or the UVLO condition recovers, the system charge control will assess the state of charge on the battery cell and will automatically resume charging in the appropriate mode for the condition of the battery.

Enable / Disable

The AAT3690 provides an enable function to control the charger IC on and off. The enable (EN) pin is active high and is internally pulled up to the higher voltage of ADP and USB supplies. When pulled to a logic low level, the AAT3690 will be shut down and forced into the sleep state. Charging will be halted regardless of the battery voltage or charging state. When the device is re-enabled, the charge control circuit will automatically reset and resume charging functions with the appropriate charging mode based on the battery charge state and measured cell voltage.

Programming Charge Current

The fast charge constant current charge level for both Adapter and USB input modes are programmed with set resistors placed between the ADPSET and USBSET pins and ground. The accuracy of the fast charge is dominated by the tolerance of the set resistor used. For this reason, 1% tolerance metal film resistors are recommended for the set resistor function.

ADP fast charge constant current levels from 100mA to 1.0A may be set by selecting the appropriate resistor value from Table 1.

The USB charge may be set to any level between 50mA and 1.0A depending upon the system design requirements for a given USB charge application. Refer to Table 1 and Figure 2 for recommended R_{SETUSB} values.

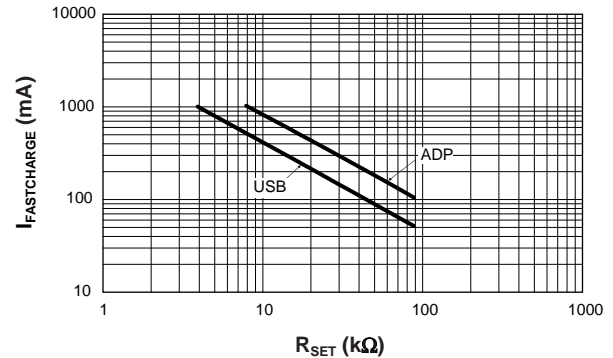

Figure 2: $I_{FASTCHARGE}$ vs. R_{SET}

Protection Circuitry

Programmable Watchdog Timer

The AAT3690 contains a watchdog timing circuit for the adapter input charging mode. No watchdog timing functions are active for the USB input mode. Typically, a 0.1μF ceramic capacitor is connected between the CT pin and ground. When a 0.1μF ceramic capacitor is used, the device will time a shutdown condition if the fast charge mode exceeds three hours. When the device transitions to the constant voltage mode, the timing counter is reset and will time out after three hours and shut down the charger.

| Mode | Time |
|-------------------------------------|---------|
| Fast Charge (CC) Time Out | 3 hours |
| Constant Voltage (CV) Mode Time Out | 3 hours |

Table 2: Summary for a 0.1μF Used for the Timing Capacitor.

The CT pin is driven by a constant current source and will provide a linear response to increases in the timing capacitor value. Thus, if the timing capacitor were to be doubled from the nominal 0.1μF value, the time-out times would be doubled.

If the programmable watchdog timer function is not needed, it may be disabled by connecting the CT pin to ground. The CT pin should not be left floating or unterminated, as this will cause errors in the internal timing control circuit.

1.0A USB Port/Adapter Li-Ion/Polymer Battery Charger

The constant current provided to charge the timing capacitor is very small, and this pin is susceptible to noise and changes in capacitance value. Therefore, the timing capacitor should be physically located on the printed circuit board layout as closely as possible to the CT pin. Since the accuracy of the internal timer is dominated by the capacitance value, 10% tolerance or better ceramic capacitors are recommended. Ceramic capacitor materials such as X7R and X5R type are a good choice for this application.

Over-Voltage Protection

An over-voltage event is defined as a condition where the voltage on the BAT pin exceeds the maximum battery charge voltage and is set by the over-voltage protection threshold (V_{OVP}). If an over-voltage condition occurs, the AAT3690 charge control will shut down the device until voltage on the BAT pin drops below the over-voltage protection threshold (V_{OVP}). The AAT3690 will resume normal charging operation after the over-voltage condition is removed. During an over-voltage event, the STAT LEDs will report a system fault.

Over-Temperature Shutdown

The AAT3690 has a thermal protection control circuit which will shut down charging functions should the internal die temperature exceed the preset thermal limit threshold.

Battery Temperature Fault Monitoring

In the event of a battery over-temperature condition, the charge control will turn off the internal pass device. The STAT LEDs will display a system fault. After the system recovers from a temperature fault, the device will resume charging operation.

The AAT3690 checks battery temperature before starting the charge cycle, as well as during all stages of charging. This is accomplished by monitoring the voltage at the TS pin. This system is intended to use negative temperature coefficient (NTC) thermistors, which are typically integrated into the battery package. Most commonly used NTC thermistors used in battery packs are approximately 10k Ω at room temperature (25°C).

The TS pin has been specifically designed to source 80 μ A of current to the thermistor. The voltage on the TS pin that results from the resistive load should stay within a window from 335mV to 2.32V. If the battery becomes

too hot during charging due to an internal fault, the thermistor will heat up and reduce in value, thus pulling the TS pin voltage lower than the T_{S1} threshold and the AAT3690 will signal the fault condition.

If the use of the TS pin function is not required by the system, it can be left open or terminated to ground using a 10k Ω resistor.

Battery Charge Status Indication

The AAT3690 has two status LED driver outputs. These two LEDs can indicate simple functions such as no battery charge activity, battery charging, charge complete, and charge fault.

Status Indicator Display

Simple system charging status may be displayed using one or two LEDs in conjunction with the STAT1 and STAT2 pins on the AAT3690. These two pins are simple switches to connect the LED cathodes to ground. It is not necessary to use both display LEDs if a user simply wants to have a single lamp to show "charging" or "not charging." This can be accomplished by using the STAT1 pin and a single LED. Using two LEDs and both STAT pins simply gives the user more information to the charging states. Refer to Table 3 for LED display definitions.

The LED anodes should be connected to either V_{USB} or V_{ADP} , depending upon the system design requirements. The LEDs should be biased with as little current as necessary to create reasonable illumination; therefore, a ballast resistor should be placed between the LED cathodes and the STAT1/2 pins. LED current consumption will add to the overall thermal power budget for the device package, so it is wise to keep the LED drive current to a minimum. 2mA should be sufficient to drive most low-cost green or red LEDs. It is not recommended to exceed 8mA for driving an individual status LED. The required ballast resistor value can be estimated using the following formulas:

For connection to the adapter supply:

$$V_{USBCHR} = 2.0V \div \frac{R12}{R12 + R11}$$

Example:

$$R_{B(STAT1/2)} = \frac{V_{ADP} - V_{F(LED)}}{I_{LED(STAT1/2)}}$$

Note: Red LED forward voltage (V_F) is typically 2.0V @ 2mA.

1.0A USB Port/Adapter Li-Ion/Polymer Battery Charger

For connection to the USB supply:

$$R_{B(STAT1)} = \frac{5.5V - 2.0V}{2mA} = 1.75k\Omega$$

Example:

$$R_{B(STAT1/2)} = \frac{V_{USB} - V_{F(LED)}}{I_{LED(STAT1/2)}}$$

Note: Green LED forward voltage (V_F) is typically 3.2V @ 2mA.

The status LED display conditions are described in Table 3.

| Event Description | STAT1 | STAT2 |
|--------------------------------|--------------------|--------------------|
| Charge Disabled or Low Supply | Off | Off |
| Charge Enabled Without Battery | Flash ¹ | Flash ¹ |
| Battery Charging | On | Off |
| Charge Completed | Off | On |
| Fault | On | On |

Table 3: Status LED Display Conditions.

Thermal Considerations

The AAT3690 is offered in a 3x3mm TDFN package which can provide up to 2.0W of power dissipation when it is properly bonded to a printed circuit board and has a maximum thermal resistance of 50°C/W. Many considerations should be taken into account when designing the printed circuit board layout, as well as the placement of the charger IC package in proximity to other heat generating devices in a given application design. The ambient temperature around the charger IC will also have an effect on the thermal limits of a battery charging application. The maximum limits that can be expected for a given ambient condition can be estimated by the following discussion:

First, the maximum power dissipation for a given situation should be calculated:

$$\text{Eq. 1: } P_D = [(V_{IN} - V_{BAT}) \cdot I_{CC} + (V_{IN} \cdot I_{OP})]$$

Where:

P_D = Total power dissipation by the device

V_{IN} = Either V_{ADP} or V_{USB} , depending on which mode is selected

V_{BAT} = Battery voltage as seen at the BAT pin

I_{CC} = Maximum constant fast charge current programmed for the application

I_{OP} = Quiescent current consumed by the charger IC for normal operation

Next, the maximum operating ambient temperature for a given application can be estimated based on the thermal resistance of the 3x3 TDFN package when sufficiently mounted to a PCB layout and the internal thermal loop temperature threshold.

$$\text{Eq. 2: } T_A = T_J - (\theta_{JA} \cdot P_D)$$

Where:

T_A = Ambient temperature in degrees C

T_J = Maximum device junction temperature below the thermal loop threshold

P_D = Total power dissipation by the device

θ_{JA} = Package thermal resistance in °C/W

Example:

For an application where the fast charge current for the adapter mode is set to 0.75A, $V_{ADP} = 5.0V$, and the worst case battery voltage is 3.6V, what is the maximum ambient temperature where the thermal limiting will become active?

Given:

$$V_{ADP} = 5.0V$$

$$V_{BAT} = 3.6V$$

$$I_{CC} = 0.75A$$

$$I_{OP} = 0.75mA$$

$$T_J = 110^\circ C$$

$$\theta_{JA} = 50^\circ C/W$$

Using Equation 3, calculate the device power dissipation for the stated condition:

$$\begin{aligned} \text{Eq. 3: } P_D &= (5.0V - 3.6V)(0.75A) + (5.0V \cdot 0.75mA) \\ &= 1.05375W \end{aligned}$$

The maximum ambient temperature before the AAT3690 thermal loop becomes active can now be calculated using Equation 4:

$$\begin{aligned} \text{Eq. 4: } T_A &= 110^\circ C - (50^\circ C/W \cdot 1.05375W) \\ &= 57.3125^\circ C \end{aligned}$$

1. Flashing rate depends on output capacitance.

DATA SHEET

AAT3690

1.0A USB Port/Adapter Li-Ion/Polymer Battery Charger

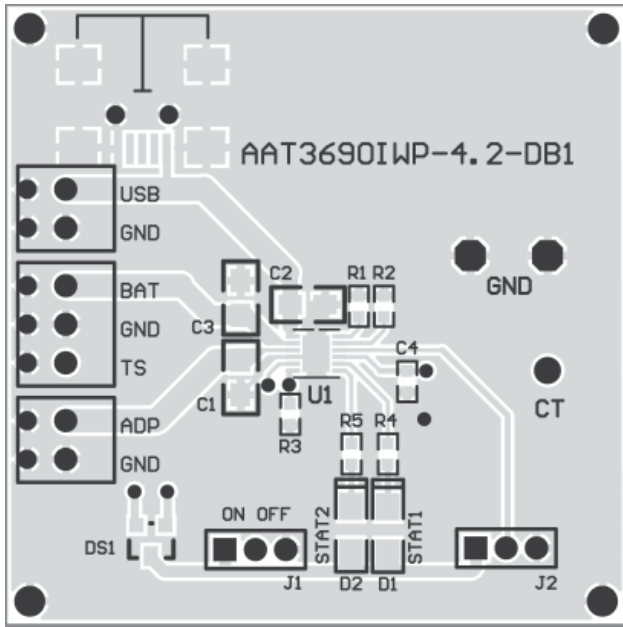

Figure 4: AAT3690 Evaluation Board Top Side Layout.

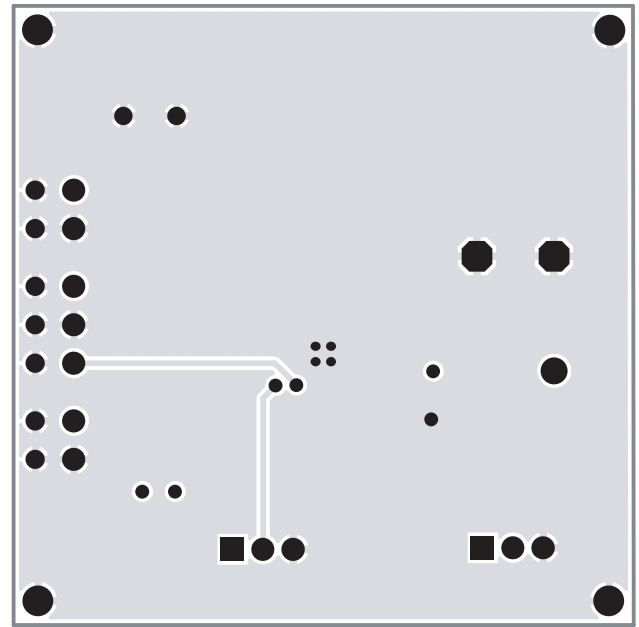

Figure 5: AAT3690 Evaluation Board Bottom Side Layout.

| Component | Part Number | Description | Manufacturer |
|------------|-------------------|---|------------------------|
| U1 | AAT3690IWP-4.2-T1 | 1.0A USB Port/Adapter Lithium-Ion/ Polymer Battery Charger; 12-Pin 3x3 TDFN Package | Skyworks |
| R1, R2 | Chip Resistor | 8.06K Ω , 1%, 1/4W; 0603 | Vishay |
| R3 | Chip Resistor | 10K Ω , 5%, 1/4W; 0603 | Vishay |
| R4, R5 | Chip Resistor | 1.5K Ω , 5%, 1/4W; 0603 | Vishay |
| C1, C2, C3 | GRM21BR61A106KE19 | CER 10 μ F 10V 10% X5R 0805 | Murata |
| C4 | GRM188R71C104KA01 | CER 0.1 μ F 16V 10% X7R 0603 | Murata |
| JP1 | PRPN401PAEN | Conn. 3-pin Header, 2mm zip | Sullins Electronics |
| JP2 | Chip Resistor | 0 Ω | Vishay |
| D1 | CMD15-21SRC/TR8 | Red LED; 1206 | Chicago Miniature Lamp |
| D2 | CMD15-21VGC/TR8 | Green LED; 1206 | Chicago Miniature Lamp |
| DS1 (a, b) | BAV74LT-A | Default Diode; SOT23-3 | On Semi |

Table 4: AAT3690 Evaluation Board Bill of Materials.

1.0A USB Port/Adapter Li-Ion/Polymer Battery Charger

Ordering Information

| Package | Marking ¹ | Part Number (Tape and Reel) ² |
|-----------|----------------------|--|
| TDFN33-12 | RUXYY | AAT3690IWP-4.2-T1 |



Skyworks Green™ products are compliant with all applicable legislation and are halogen-free. For additional information, refer to *Skyworks Definition of Green™*, document number SQ04-0074.

Package Information³

TDFN33-12

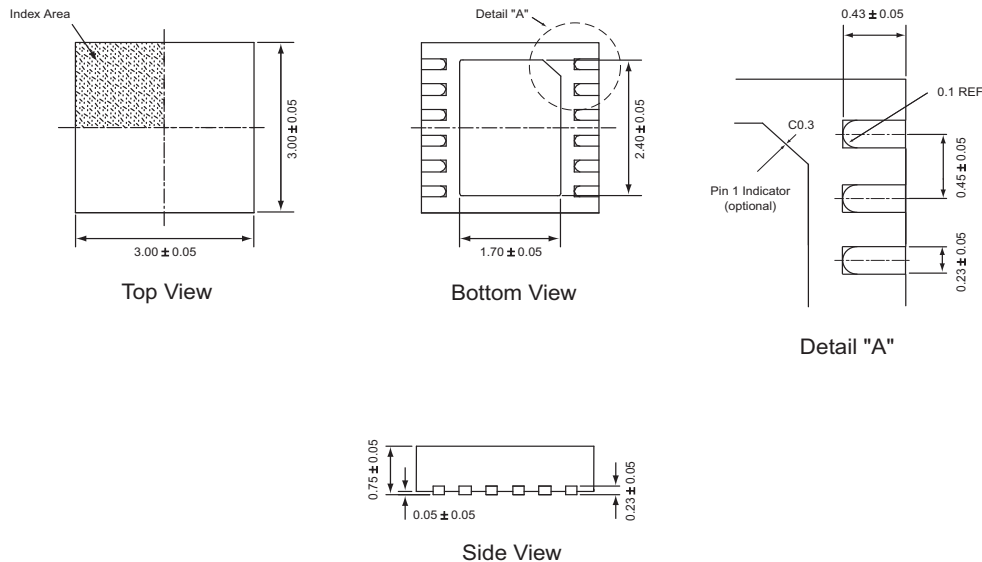

All dimensions in millimeters.

1. XYY = assembly and date code.
2. Sample stock is generally held on part numbers listed in **BOLD**.
3. The leadless package family, which includes QFN, TQFN, DFN, TDFN and STDFN, has exposed copper (unplated) at the end of the lead terminals due to the manufacturing process. A solder fillet at the exposed copper edge cannot be guaranteed and is not required to ensure a proper bottom solder connection.

Copyright © 2012 Skyworks Solutions, Inc. All Rights Reserved.

Information in this document is provided in connection with Skyworks Solutions, Inc. ("Skyworks") products or services. These materials, including the information contained herein, are provided by Skyworks as a service to its customers and may be used for informational purposes only by the customer. Skyworks assumes no responsibility for errors or omissions in these materials or the information contained herein. Skyworks may change its documentation, products, services, specifications or product descriptions at any time, without notice. Skyworks makes no commitment to update the materials or information and shall have no responsibility whatsoever for conflicts, incompatibilities, or other difficulties arising from any future changes.

No license, whether express, implied, by estoppel or otherwise, is granted to any intellectual property rights by this document. Skyworks assumes no liability for any materials, products or information provided hereunder, including the sale, distribution, reproduction or use of Skyworks products, information or materials, except as may be provided in Skyworks Terms and Conditions of Sale.

THE MATERIALS, PRODUCTS AND INFORMATION ARE PROVIDED "AS IS" WITHOUT WARRANTY OF ANY KIND, WHETHER EXPRESS, IMPLIED, STATUTORY, OR OTHERWISE, INCLUDING FITNESS FOR A PARTICULAR PURPOSE OR USE, MERCHANTABILITY, PERFORMANCE, QUALITY OR NON-INFRINGEMENT OF ANY INTELLECTUAL PROPERTY RIGHT; ALL SUCH WARRANTIES ARE HEREBY EXPRESSLY DISCLAIMED. SKYWORKS DOES NOT WARRANT THE ACCURACY OR COMPLETENESS OF THE INFORMATION, TEXT, GRAPHICS OR OTHER ITEMS CONTAINED WITHIN THESE MATERIALS. SKYWORKS SHALL NOT BE LIABLE FOR ANY DAMAGES, INCLUDING BUT NOT LIMITED TO ANY SPECIAL, INDIRECT, INCIDENTAL, STATUTORY, OR CONSEQUENTIAL DAMAGES, INCLUDING WITHOUT LIMITATION, LOST REVENUES OR LOST PROFITS THAT MAY RESULT FROM THE USE OF THE MATERIALS OR INFORMATION, WHETHER OR NOT THE RECIPIENT OF MATERIALS HAS BEEN ADVISED OF THE POSSIBILITY OF SUCH DAMAGE.

Skyworks products are not intended for use in medical, lifesaving or life-sustaining applications, or other equipment in which the failure of the Skyworks products could lead to personal injury, death, physical or environmental damage. Skyworks customers using or selling Skyworks products for use in such applications do so at their own risk and agree to fully indemnify Skyworks for any damages resulting from such improper use or sale.

Customers are responsible for their products and applications using Skyworks products, which may deviate from published specifications as a result of design defects, errors, or operation of products outside of published parameters or design specifications. Customers should include design and operating safeguards to minimize these and other risks. Skyworks assumes no liability for applications assistance, customer product design, or damage to any equipment resulting from the use of Skyworks products outside of stated published specifications or parameters.

Skyworks, the Skyworks symbol, and "Breakthrough Simplicity" are trademarks or registered trademarks of Skyworks Solutions, Inc., in the United States and other countries. Third-party brands and names are for identification purposes only, and are the property of their respective owners. Additional information, including relevant terms and conditions, posted at www.skyworksinc.com, are incorporated by reference.